

Standard-Schraubkloben

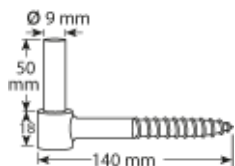

Standard-Ladenfeststeller

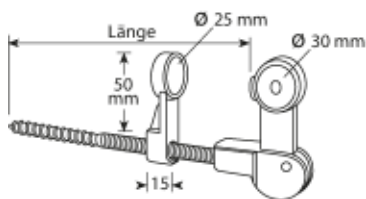

Ladenfeststeller mit Frauenkopf

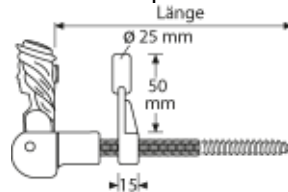

Standard-Ladenband

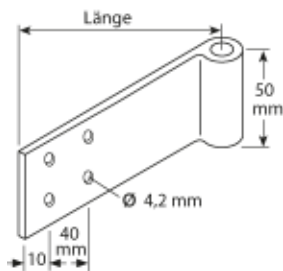

Schnellmontage-Kreuzband
vertikal und horizontal verstellbar
(alternativ)

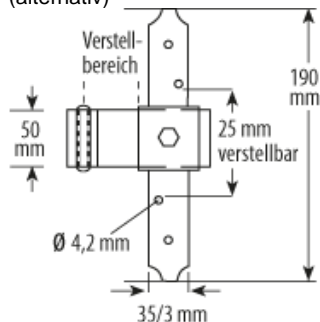

Kreuzband
horizontal verstellbar
(alternativ)

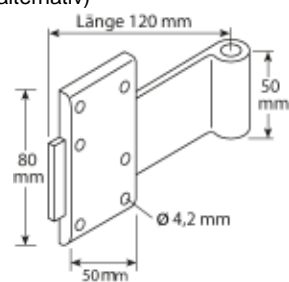

Standard-Ladenverschluss

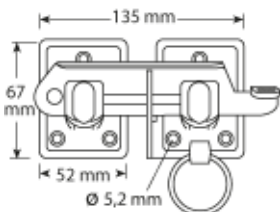

Doppelkrallenverschluss
zu Typ AV + AJÜ

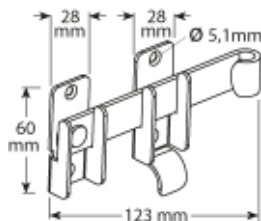

Standard-Ladenscharnier
gekröpft (bei gekuppelten Läden)

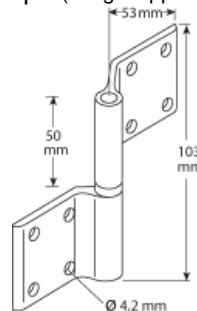

Standard-Ladenriegel
(Länge 120+220 mm)

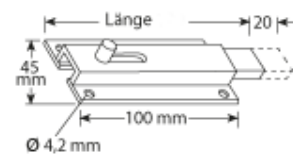

Alu-Winkel zu Ladenriegel
(Schema 1 – bündig mit der Leibung)

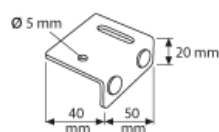

Riegelanschlag zu Ladenriegel
(Schema 4 – über die Leibung)

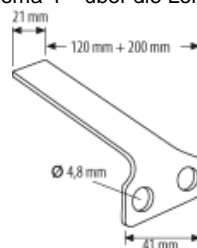

Kugelschnapper
für gekuppelte Fensterläden

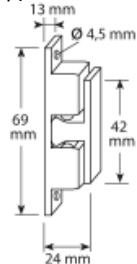

Ladenhalter für gekuppelte Türblenden
(Schema 1 – bündig mit der Leibung)

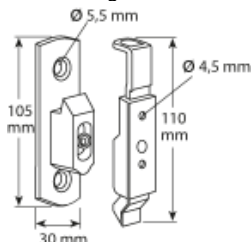

Ladenhalter für gekuppelte Türblenden
(Schema 4 – über die Leibung)

